



PYLE[®] **PRO**

PEA4000/6000

**PROFESSIONAL 4000/6000 WATTS
STEREO POWER AMPLIFIER**



www.pyleaudio.com

OWNER'S MANUAL

Important safety instructions



This symbol, wherever it appears, alerts you to the presence of uninsulated dangerous voltage inside the enclosure-voltage that may be sufficient to constitute a risk of shock.



This symbol, wherever it appears, alerts you to important operating and maintenance instructions in the accompanying literature. Please read the manual.

Caution



To reduce the risk of electric shock, do not remove the top cover (or the rear section). No user serviceable parts inside; refer servicing to qualified personnel.



To reduce the risk of fire or electric shock, do not expose this appliance to rain and moisture. The apparatus shall not be exposed to dripping or splashing and no objects filled with liquids, such as vases, shall be placed on the apparatus.



These service instructions are for use by qualified service personnel only. To reduce the risk of electric shock do not perform any servicing other than that contained in the operation instructions unless you are qualified to do so.



We would like to bring your attention to the fact that extremely loud sound levels may damage your hearing as well as your loudspeakers. Please lower both GAIN controls leftwards before powering up the unit. Be sure to keep the volume at an appropriate level.

Ventilation :



The appliance should be situated so that its location or position does not interfere with its proper ventilation. For example, the appliance should not be situated on a bed, sofa rug, or similar surface that may block the ventilation openings; or placed in a built-in installation, such as a bookcase or cabinet that may impede the flow of air through the ventilation openings.

- 1) Read these instructions.
- 2) Keep these instructions.
- 3) Heed all warnings.
- 4) Follow all instructions.
- 5) Do not use this apparatus near water.
- 6) Clean only with dry cloth.
- 7) Do not block any ventilation openings. Install in accordance with the manufacturer's instructions.
- 8) Do not install near any heat sources such as radiators, heat registers, stoves, or other apparatus (including amplifiers) that produce heat.
- 9) Do not defeat the safety purpose of the polarized or grounding-type plug. A polarized plug has two blades with one wider than the other. A grounding type plug has two blades and a third grounding prong. The wide blade or the third prong are provided for your safety. If the provided plug does not fit into your outlet, consult an electrician for replacement of the obsolete outlet.
- 10) Protect the power cord from being walked on or pinched particularly at plugs, convenience receptacles, and the point where they exit from the apparatus.
- 11) The apparatus shall be connected to a MAINS socket outlet with a protective grounding connection.
- 12) Where the MAINS plug or an appliance coupler is used as the disconnect device, the disconnect device shall remain readily operable.
- 13) Only use attachments / accessories specified by the manufacturer.
- 14) Use only with the cart, stand, tripod, bracket, or table specified by the manufacturer, or sold with the apparatus. When a cart is used, use caution when moving the cart / apparatus combination to avoid injury from tip-over.
- 15) Unplug this apparatus during lightning storms or when unused for long periods of time.
- 16) Refer all servicing to qualified service personnel. Servicing is required when the apparatus has been damaged in any way, such as power supply cord or plug is damaged, liquid has been spilled or objects have fallen into the apparatus, the apparatus has been exposed to rain or moisture, does not operate normally, or has been dropped.



PYLE PRO

Power amplifier with 2×700 or 2×1200 Watts

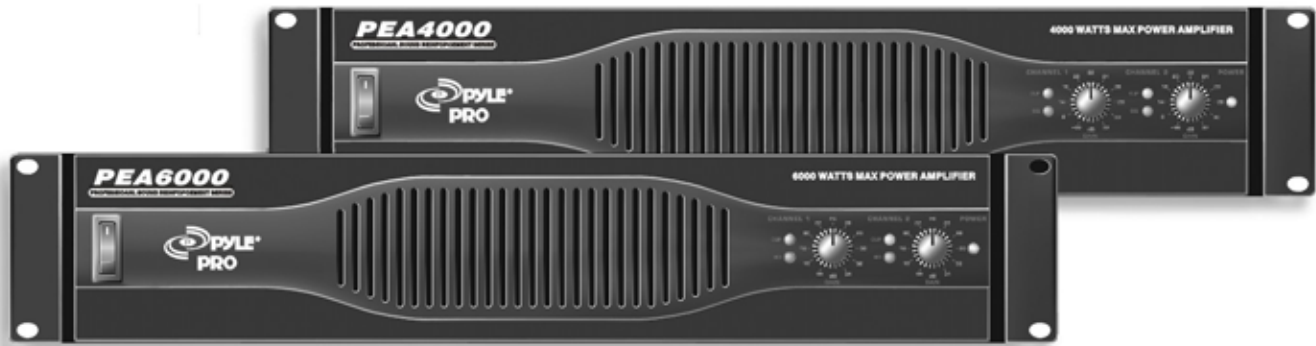

- ▲ **PEA4000:** 2×700 Watts into 2 Ohms; 1,400 Watts into 4 Ohms bridged operation
- ▲ **PEA6000:** 2×1,200 Watts into 2 Ohms; 2,400 Watts into 4 Ohms bridged operation
- ▲ 2-channel, parallel or bridged mono operating modes for flexible application
- ▲ Independent limiters for each channel offer dependable protection against distortion
- ▲ Precise signal and clip LED indicators to monitor performance
- ▲ Selectable low-frequency filters (30 Hz or 50 Hz) remove distracting infra-sound frequencies
- ▲ Professional connectors, compatible with Neutrik Speakon connectors, and “touch-proof” binding post loudspeaker outputs enable secure operation
- ▲ Balanced XLR and 1/4” TRS inputs
- ▲ Connection option for extra amps in parallel operation
- ▲ Ultra-reliable Toshiba/Fairchild high-power transistors
- ▲ High-current toroidal transformer for absolute reliability and lowest noise emission
- ▲ “Back-to-front” ventilation system including air filter with automatically adjusting fan speed for smooth operation
- ▲ Independent DC and thermal overload protection on each channel automatically protects amplifier and speakers
- ▲ High-quality components and exceptionally rugged construction ensure long life

Foreword

Dear Customer,

Welcome to the team of PYLE PRO users, and thank you very much for expressing your confidence in us by purchasing this power amplifier.

Writing this foreword for you gives me great pleasure, because it represents the culmination of many months of hard work delivered by our engineering team to achieve a very ambitious goal: to develop two outstanding power amplifiers, whose flexibility lets them respond to all the P.A. and instrument amplification requirements. The task of designing our new PYLE PRO PEA4000 and PEA6000 certainly meant a great deal of responsibility, which we assumed by focusing on you, the discerning user and musician. Meeting your expectations also meant a lot of work and night shifts. But it was fun, too. Developing a product usually brings a lot of people together, and what a great feeling it is when all who participated in such a project can be proud of what they've achieved.

It is our philosophy to share our enjoyment with you, because you are the most important member of the PYLE PRO team. With your highly competent suggestions for new products you've made a significant contribution to shaping our company and making it successful. In return, we guarantee you uncompromising quality as well as excellent technical and audio properties at an extremely reasonable price. All of this will enable you to give free rein to your creativity without being hampered by budget constraints.

We are often asked how we manage to produce such high-quality devices at such unbelievably low prices. The answer is quite simple: it's you, our customers! Many satisfied customers mean large sales volumes enabling us to get better purchasing terms for components, etc. Isn't it only fair to pass this benefit on to you? Because we know that your success is our success too!

I would like to thank all of you who have made the PYLE PRO power amplifiers possible. You have all made your own personal contributions, from the developers to the many other employees at this company, and to you, the PYLE PRO user.

My friends, it's been worth the effort!

Table of Contents

1. Introduction..... 5
 1.1 Before you get started..... 5
 1.1.1 Shipment..... 5
 1.1.2 Initial operation 5
 1.1.3 Online registration..... 5
2. Control elements..... 6
 2.1 Front panel..... 6
 2.2 Rear panel..... 6
 2.3 Configuration switches(MODE SWITCHES)..... 7
 2.3.1 Clip limiter..... 7
 2.3.2 Input filter 7
 2.3.3 2-channel mode(stereo)..... 7
 2.3.4 Parallel mode..... 7
 2.3.5 Mono-bridged mode..... 7
3.Applications..... 7
 3.1 Differences between 2-channel, parallel and mono-bridged operating modes..... 7
 3.2 Bi-amping..... 9
4. Installation..... 10
 4.1 Connections..... 10
 4.1.1 Using the binding posts..... 11
 4.1.2 Connecting to the mains..... 11
 4.2 Audio connections..... 11
5. Specifications..... 12
6. Warranty..... 13

1.Introduction

By purchasing one of the PYLE PRO products amplifiers, you have selected a piece of high-end gear. This unit was developed for professional use in live applications, and its rich list of features will make it a dependable part of your equipment with a diverse set of possible uses.

The PYLE PRO amps feature for example an input filter for each channel, enabling you to remove the disturbing low-frequency portion of the signal. Additionally, there is a limiter that protects your loudspeakers. Various operating modes, such as parallel or mono mode, open up various possibilities for effective implementation with the rest of your audio equipment, leaving no wishes unanswered.

 **This manual first describes the terminology used, so that you fully understand the PYLE PRO and its functions. Please read the manual carefully and keep it for future reference.**

1.1 Before you get started

1.1.1 shipment

Your PYLE PRO Products was carefully packed at the factory, and the packaging is designed to protect the unit from rough handling. Nevertheless, we recommend that you carefully examine the packaging and its contents for any signs of physical damage, which may have occurred during transit.

 **If the unit is damaged, please do NOT return it to PYLE PRO, but notify your dealer and the shipping company immediately. Otherwise, claims for damage or replacement may not be granted.**

1.1.2 Initial operation

Please make sure the unit is provided with sufficient ventilation, and never place your PYLE PRO amp on top of other heatemanating equipment or in the vicinity of a heater to avoid the risk of overheating.

The mains connection is made via the enclosed power cord and a standard IEC receptacle. It meets all international safety certification requirements.

 **Please make sure that all units have a proper ground connection. For you own safety, never remove or disable the ground conductor from the unit or the AC power cord.**

 **The sound quality may diminish within the range of powerful broadcasting stations and high-frequency sources. Increase the distance between the transmitter and the device and use shielded cables for all connections.**

1.1.3 Online registration

Please register your new PYLE PRO equipment right after your purchase by visiting <http://www.pyleaudio.com> and read the terms and conditions of our warranty carefully.

Should your PYLE PRO product malfunction, it is our intention to have it repaired as quickly as possible. To arrange for warranty service, please contact the PYLE PRO retailer from whom the equipment was purchased. Should your PYLE PRO dealer not be located in your vicinity, you may directly contact one of our subsidiaries. Corresponding contact information is included in the original equipment packaging. Should your country not be listed, please contact the distributor nearest you. A list of distributors can be found in the support area of our website (<http://www.pyleaudio.com>). Registering your purchase and equipment with us helps us process your repair claims more quickly and efficiently.

Thank you for your cooperation!

2. Control elements

Since control elements of both the PEA4000 and the PEA6000 are identical, we have used the PEA4000 as the model represented in the illustrations to assure simplicity.

2.1 Front panel

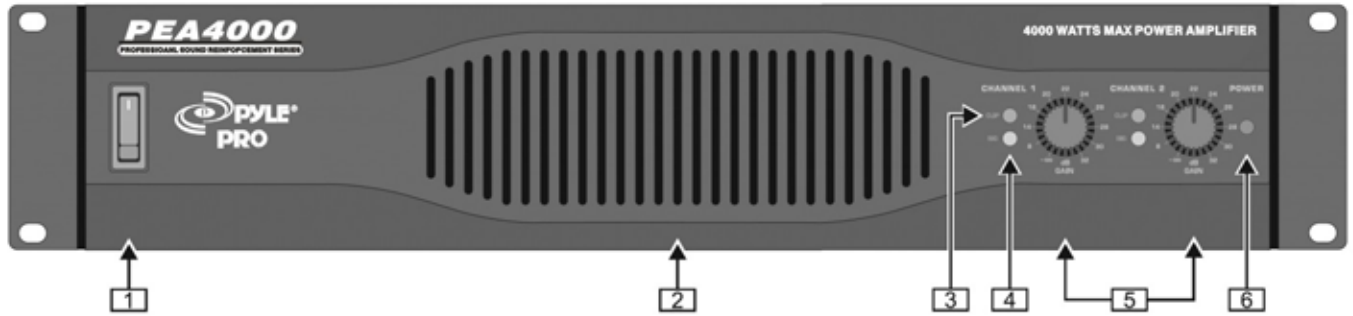

Fig. 2.1: Front panel control elements

- 1 The main switch is used to power up the amp.
- 2 Merely switching the unit off does not mean that it is fully disconnected from the mains. When not using the unit for prolonged periods of time, please unplug the unit's power cord from the power outlet.
- 2 Ventilation openings are located at the front of the unit, so that hot air is prevented from being trapped inside the unit, thus causing faulty operation or even damage.
- 3 The CLIP LED lights up when the signal is distorted. Should distortion occur, reduce the input level, so that the CLIP LED stops lighting up.
- 4 The SIGNAL LED lights up as long as a signal is present at the input.
- 5 The Gain control (channels 1 and 2) is used for setting up the input gain.
- 6 The POWER LED lights up as soon as the unit is powered up.

2.2 Rear panel

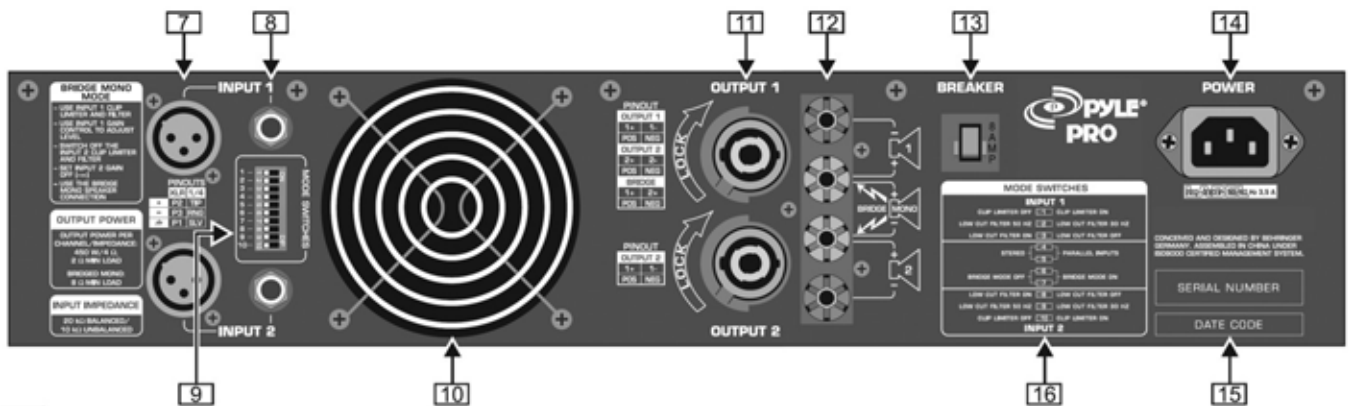

Fig. 2.2: Rear panel control elements

- 7 These are the balanced XLR inputs (channels 1 and 2).
- 8 These are the stereo 1/4" TRS inputs (channels 1 and 2). They can also be used with unbalanced plugs.
- 9 These are the MODE switches, used to alter the operating modes as well as to set the limiters and high-pass filters (see chapter 2.3).
- 10 The unit's fan is located here. Fan speed adjusts automatically to assure trouble-free operation.
- 11 To prevent faulty operation, please assure that the unit is kept at a distance from other appliances emanating heat.
- 11 These are the Speakon-compatible outputs (channels 1 and 2). When running the unit in mono-bridged mode (see chapter 2.3.5), please use the channel 1 output exclusively. For further information on the connectors please refer to chapter 4.1.
- 12 These are the output terminals (channels 1 and 2). When running in mono, please make sure to use both middle connectors to connect your loudspeaker.
- 13 BREAKER (automated fuse). After eliminating the cause of faulty operation, simply depress the BREAKER and power up the unit again. The BREAKER acts in place of common discarable fuses.

Caution

- Before engaging the BREAKER switch, you should power down the unit (POWER switch set to OFF)!

- 14 Power is supplied via an IEC connector. The matching cable is provided with the unit.
- 15 SERIAL NUMBER of your PYLE PRO.
- 16 Here you can find a detailed overview of the individual MODE SWITCHES functions(9).

2.3 Configuration switches (MODE SWITCHES)

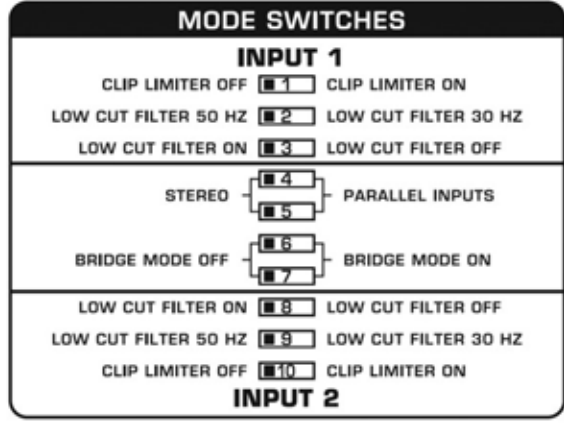

Fig 2.3: DIP-switches

2.3.1 Clip limiter

When the input signal connected to your amp is too high, you end up with a distorted output signal. To prevent this, both channels of your PYLE PRO feature a clip limiter that can be engaged or disengaged selectively. The limiters automatically recognize distortion and lower amplification until distortion is reduced to a tolerable level. To preserve the dynamic characteristics of the signal when low distortion levels are occurring, the clip limiters function with moderate suppression. Use switches 1 (ch. 1) and 10(ch. 2) to activate the clip limiters.

When using broadband loudspeaker systems, the clip limiter reduces high frequency distortions which occur when an amplifier is overloaded. The drivers are thus protected from being damaged.

2.3.2 Input filter

The LF (high-pass) filter removes frequencies below 30 and 50 Hz respectively. The reproduction of the signal's bass portion is thus optimized, since ultra-low, distracting frequencies are eliminated, and more power is available for the reproduction of the wanted segment of the signal. Engaging and disengaging the filters is done by using the switches 3 (ch. 1) and 8 (ch. 2). Switches 2 (ch. 1) and 9 (ch. 2) determine the cut-off frequency. As long as the filter is disengaged, frequencies below 5 Hz are cut to prevent damage. You should set up the filters so they best suit the frequency response of your speakers, since some speakers (e.g. bass reflex speakers) are particularly sensitive to over-exursion below the listed frequency range.

The 50 Hz filter should be engaged when using broadband speakers because the filter provides a moderate amplification in the 100-Hz range, resulting in a fuller sound. The 30 Hz filter is ideally suited for subwoofer operation as well as for broadband cabinets. The "Off" setting should be used only for special applications (e.g. studio applications), in which recognizing and subsequently removing infra-sound is important.

2.3.3 2-channel mode (stereo)

Both channels of your amp function independently from one another in this operating mode, and each has its own input signal. Two independent speakers are connected at the outputs. To activate this operating mode, please set the MODE SWITCHES 4 and 5 to "STEREO".

⚠ When running the unit in two-channel mode, the switches for mono-bridged mode must be disengaged (dip switches 6 and 7 in left position).

2.3.4 Parallel mode

Running in parallel mode enables you to feed a signal via one of the inputs into both outputs. Each channel drives its own loudspeaker with independent amplification, filter and limit characteristics. To link the inputs, set the MODE SWITCHES 4 and 5 to "PARALLEL INPUTS".

⚠ Mono-bridged mode switches must be disengaged when running in parallel mode.

With inputs set to parallel, you can use the remaining input connectors to feed the signal into additional amplifiers. This means that the channel 2 inputs function as outputs.

The parallel mode is well-suited for applications in which driving two speakers with the same signal but with separate amplification, filter and limiter settings is desired.

2.3.5 Mono-bridged mode

This operating mode enables you to add up the respective voltage of both channels and use it to drive a single loudspeaker. The voltage is therefore doubled, the peak power is quadrupled, and program power is roughly three times as high as that of the individual channels. The input, output, gain, filter and limiter controls belonging to channel 1 are used when running in mono-bridged mode. The controls belonging to channel 2 are not used. To prevent signal cancellation due to internal phase inversion, the GAIN control belonging to channel 2 must be turned to its left-most position.

Use this operating mode to route the power from both channels to a single 8-Ohm or 4-Ohm load. To do so, set up the switches 6 and 7 to "BRIDGE MODE ON". To use the binding posts as your output, you MUST use the two middle posts only.

⚠ The mono-bridged mode puts added demands on amplifier and speakers. Excessive distortion may occasionally completely mute the amp's outputs as well as cause permanent damage to the speakers. Please assure that your speakers (minimal impedance 4 Ohms) as well as the cables used can handle the extra power generated in this mode.

3.Applications

Running PYLE PRO amplifiers in conjunction with 8-Ohm speakers with a power rating of at least 2×260 Watts (PEA4000) and 2×450 Watts (PEA6000) is recommended to assure optimal operation.

3.1 Differences between 2-channel, parallel and monobridged operating modes

2-channel mode is the most common operating mode of amplifiers. Both channels operate fully independently from one another. There is always a separate input signal as well as a separate output signal.

PYLE PRO PEA4000/PEA6000

Examples:

- ▲ 2-channel (stereo) playback
- ▲ Two independent mono signals, e.g. instrument signal and monitor mix
- ▲ Bi-amp operation, whereby bass frequencies are run on channel 1, and high frequencies on channel 2 (see chapter 3.2 "Bi-amping").

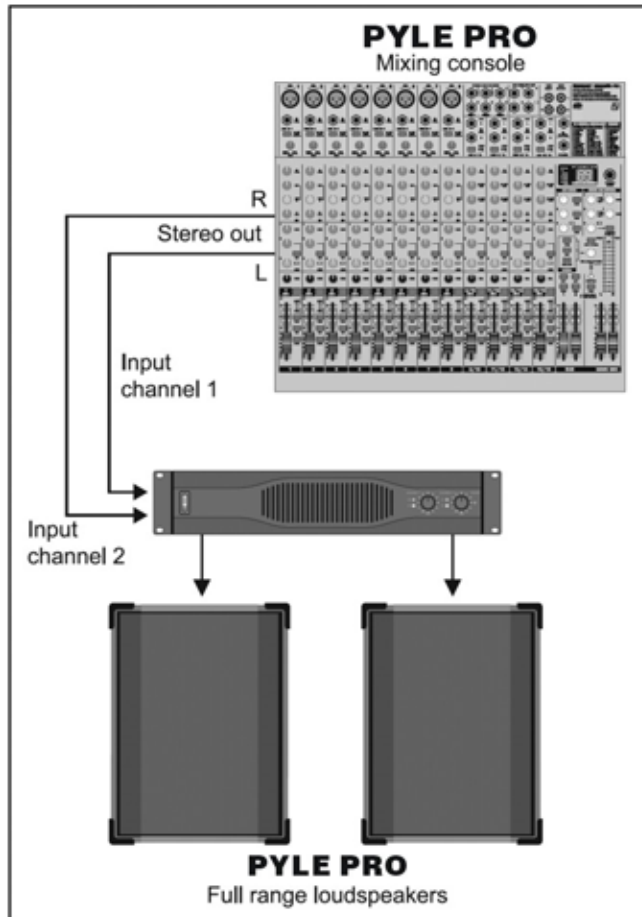

Fig .3.1:2-channel mode

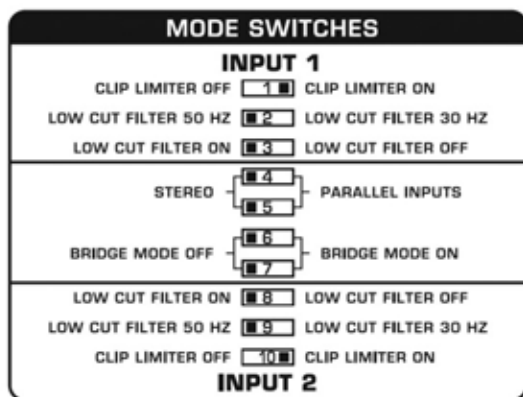

Fig .3.2: DIP switch positions for 2-channel operation

Parallel mode is identical to 2-channel mode, except for the inputs of both channels are internally connected in parallel. One input signal routes parallel both channels, while their filters ect. are independently controlled.

Examples:

- ▲ A mono signal is fed into both channels, whereby amplification of each channel is controlled separately.
- ▲ Parallel mode (as described above) with connection of an additional amp via the remaining free input connector. The input signal is present there and may be connected to further equipment.

⚠ When connecting a balanced input signal, please make sure to exclusively use balanced cables for passing the signal further on. Otherwise, a singer unbalanced cable can turn the entire signal unbalanced.

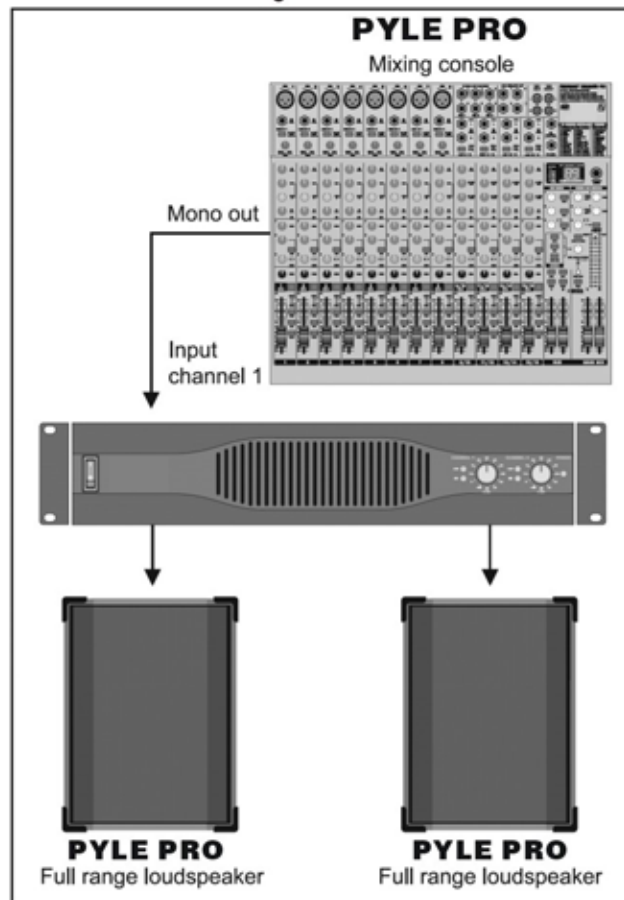

Fig .3.3 : Parallel operation

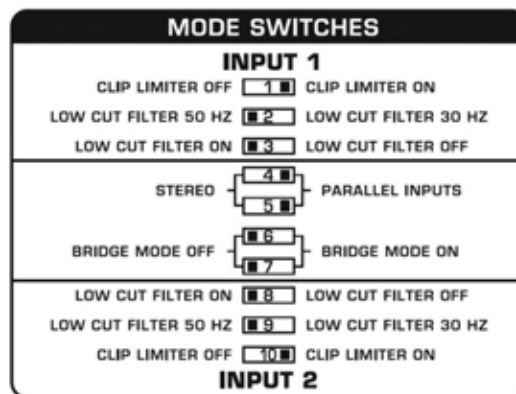

Fig .3.4:DIP switch positions for parallel operation

When running in mono-bridged mode, the voltage of both channels is added up and fed into a single loudspeaker system. There is one input and one output signal respectively, and only the controls of channel 1 (and not of channel 2) are used.

⚠ However , should the DIP switches 4 and 5 still be in PARALLEL INPUTS position while in mono-bridged mode, the signal on the free input (input channel 2) can be forwarded to an additional amp.

Examples:

- ▲ Driving a single 8-Ohm loudspeaker.
- ▲ Driving a single 4-Ohm loudspeaker.

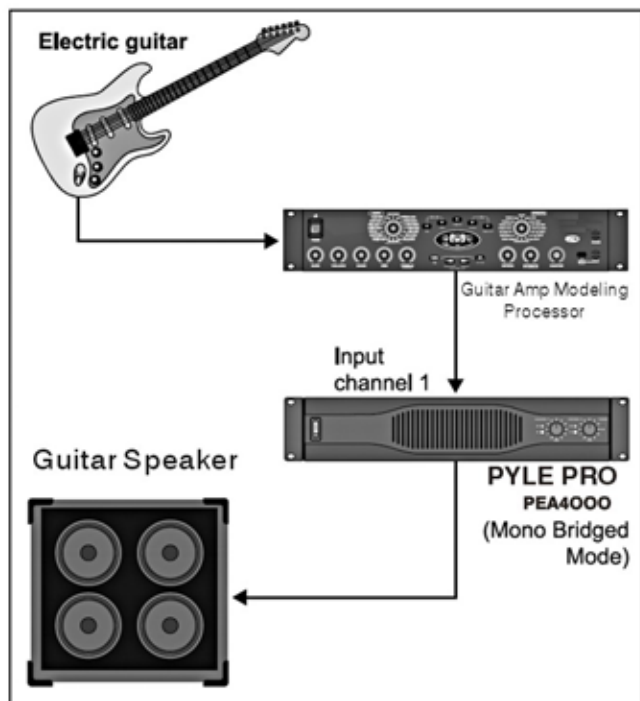

Fig .3.5: Mono-bridged mode

MODE SWITCHES	
INPUT 1	
CLIP LIMITER OFF <input type="checkbox"/>	CLIP LIMITER ON <input checked="" type="checkbox"/>
LOW CUT FILTER 50 HZ <input checked="" type="checkbox"/>	LOW CUT FILTER 30 HZ <input type="checkbox"/>
LOW CUT FILTER ON <input checked="" type="checkbox"/>	LOW CUT FILTER OFF <input type="checkbox"/>
STEREO <input type="checkbox"/>	PARALLEL INPUTS <input checked="" type="checkbox"/>
BRIDGE MODE OFF <input type="checkbox"/>	BRIDGE MODE ON <input checked="" type="checkbox"/>
INPUT 2	
LOW CUT FILTER ON <input checked="" type="checkbox"/>	LOW CUT FILTER OFF <input type="checkbox"/>
LOW CUT FILTER 50 HZ <input checked="" type="checkbox"/>	LOW CUT FILTER 30 HZ <input type="checkbox"/>
CLIP LIMITER OFF <input type="checkbox"/>	CLIP LIMITER ON <input checked="" type="checkbox"/>

Fig.3.6:DIP switch positions for mono-bridged mode

When the amp is overdriven for longer periods of time, the output signal may occasionally be muted for several seconds. In certain situations, excessive overdriving may trigger off the automated fuse. To avoid overdriving the amp, please continually make sure that an appropriate volume level is applied.

Caution

- 2-Ohm loads should never be applied when in mono-bridged mode.
- When connecting a balanced input signal, please make sure to exclusively use balanced cables for passing the signal further on. Otherwise, a single unbalanced cable can turn the entire signal unbalanced.

Safety precautions for mono-bridged operation

Running your amp in mono-bridged mode can quickly result in excessive overdriving and premature shutting down of the unit itself. In the worst-case scenario, your loudspeakers may be damaged permanently. Therefore, you should always make sure that the speakers you use can indeed handle the power load fed into them.

A volatage of up to 100 VRMS is present between the output connectors of the PEA6000. Always implement appropriate safety precautions when connecting your speakers to avoid the risk of electric shock.

3.2 Bi-amping

By using an active crossover, you can divide up the frequency range into several bands. For example, in doing so you can split a mono signal into upper-frequency and lower-frequency ranges. These two signals can then be hooked up to the inputs of your amp, so that channel 1 amplifies the lows and channel 2 amplifies the highs (2-channel operation). The outputs are connected to a 2-way speaker, whereby the output signal 1 drives the woofer and output signal 2 runs the drivers. Of course, you can use two separate speakers instead of a single 2-way speaker.

A stereo signal can also be split up analogous to the example described above. However, to do that you need two 2-way speakers or 4 separate speakers, two PYLE PRO amps and an active 2-way stereo crossover. By deploying a third PEA4000 amp (preferably in mono-bridged mode) and a subwoofer, you have a perfect setup that adds a low-frequency system to the stereo bi-amp application (see fig.3.4). The amp's input filters for the high/ mid-frequency ranges should in this case be engaged and set at 50 Hz. To remove low, disturbing frequencies from the signal, the input filter for the subwoofer signal should be set at 30 Hz.

The PYLE PRO loudspeakers are an out-standing solution for expanding your P.A.system, because each frequency range/application has a speaker type that optimally suits its characteristics.

Extreme clip limiter settings in bi-amp operating mode can result in balance shifting.

PYLE PRO PEA4000/PEA6000

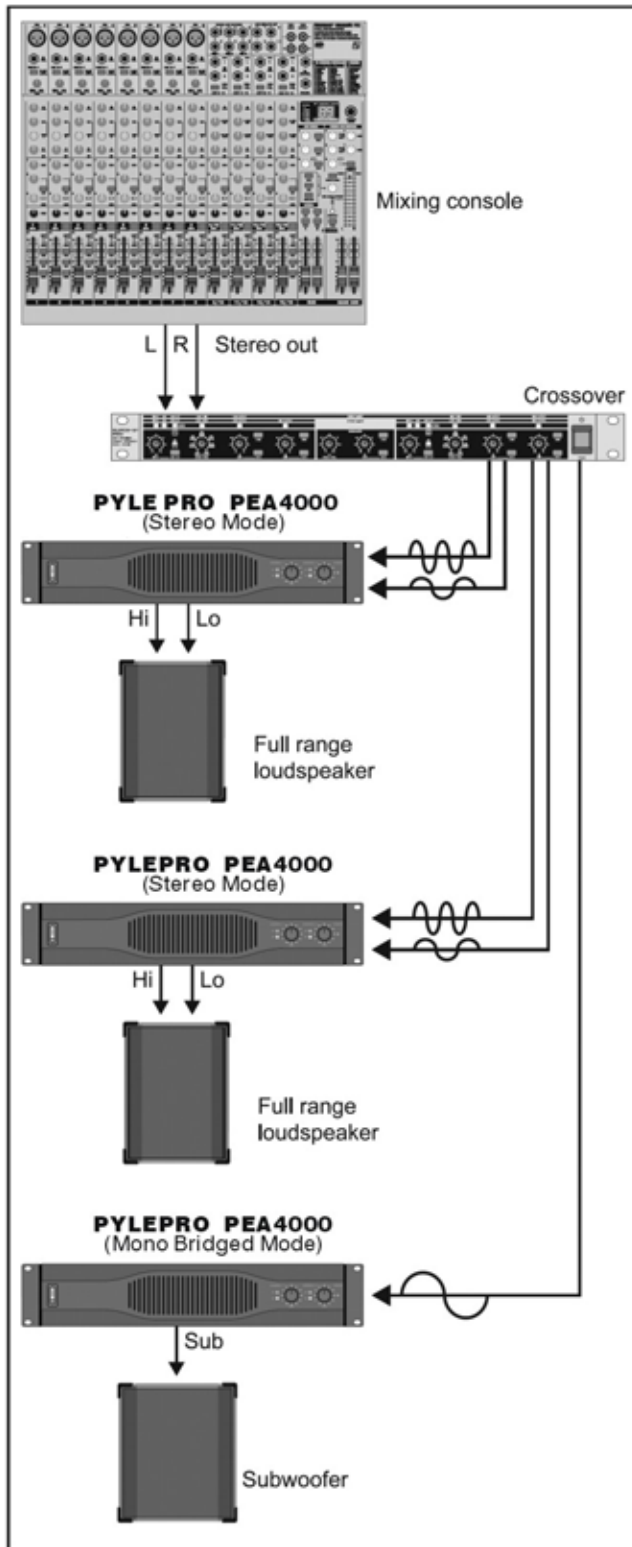

Fig. 3.7: Stereo bi-amp mode with a separate subwoofer

4. Installation

Your PYLE PRO can be installed into a 19" rack and requires two rack units. Please use for attaching screws and washers for installation. Reinforce the back end, especially for on-the-road use. Please assure that enough cool air reaches the rack, especially when other rack equipment emanates a lot of heat. In the case of the PYLE PRO PEA4000 and PEA6000, hot air circulates at the front of the unit to thermally relieve the rack enclosure.

Hand icon: Fan speed adjusts automatically and assures safe operation. Never block ventilation openings. Should internal temperature reach extreme values, the unit will shut down automatically.

4.1 Connections

Inputs

Each channel features balanced XLR and 1/4" TRS stereo jack inputs, with input impedances of 20 kΩ (balanced) and 10 kΩ (unbalanced). In general, balanced signals cause less noise than unbalanced signals.

For balanced input signals, use the XLR and 1/4" TRS stereo inputs. For unbalanced input signals, use the unused pin of the XLR connector with grounding. No alteration is necessary on mono jack connectors.

Hand icon: Should you register distracting signals such as noise or hissing, we recommend separating the amp input from the signal source. This way, you can quickly determine if the noise originates in the equipment connected to the amp. Always make sure to completely lower amplification of both channels before powering up the amp (GAIN control turned all the way leftward). Otherwise, permanent damage to your speakers may occur.

Outputs

Your PYLE PRO offers several output connection possibilities: two Neutrik Speakon-compatible connectors and two pairs of touch-safe binding posts. The Speakon connectors were especially developed for driving high-power speakers. They snap in securely, prevent electric shock and assure correct polarity. The upper connector drives either one or both channels, and is therefore well-suited for mono-bridged operation (1+/2+). The lower connector carries the signals from channel 2 only.

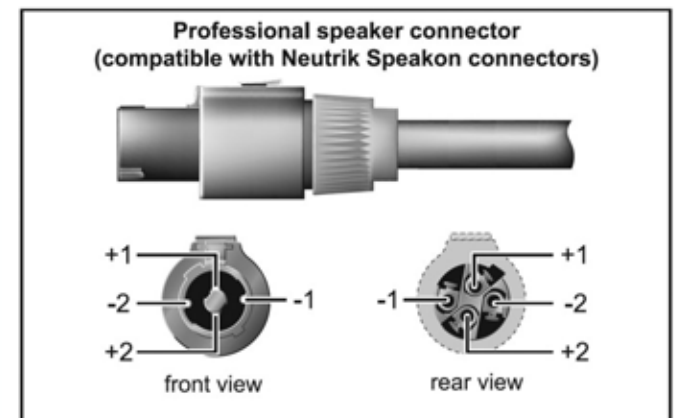

Fig. 4.1: Neutrik Speakon-compatible connectors

Hand icon: Whenever possible, use thick and short speaker cables to minimize power losses. Never lay out output cables near input cables.

4.1.1 Using the binding posts

To connect the loudspeakers to the amplifier's binding posts, please do the following:

1. Switch off the amp and disconnect it from the mains (unplug mains connector).
2. Remove the protective plastic covers shielding the binding posts by loosening the two screws on the right-hand side of the connections and lift the plastic cover upwards.
3. Attach the terminal of your loudspeaker cable to the corresponding binding post.
4. Place the protective plastic covers into its original upright position on each binding post and replace the two screws.

⚠ Never operate the device without the protective plastic covers in place!

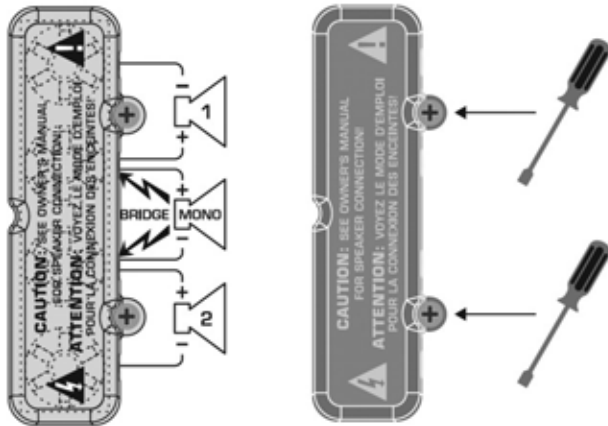

Fig .4.2: Protective plastic covers shielding the binding posts

When using binding post connectors, please make sure that insulation on cables is not removed too high. Insert the naked part of the cable fully so that no metal is visible. Cable clamps must be isolated to avoid the possibility of electric shock. When running the amp in mono-bridged mode, always use the middle two binding post connectors, paying attention to correct polarity.

Caution

⚠ If you notice naked cable endings on the binding post connectors, do not power up the amp because of the risk of electric shock.

4.1.2 Connecting to the mains

Always connect your PYLE PRO amplifier to the voltage specified on the rear of the device. Connecting the amp to an incorrect voltage can permanently damage your amp.

Before powering up the amplifier, double-check all connections and fully lower the gain setting.

4.2 Audio connections

Various cables are needed for different types of applications. The following illustrations show the correct wiring. Always use high-grade cables.

⚠ When connecting a balanced input signal, please make sure to exclusively use balanced cables for passing the signal further on. Otherwise, one single unbalanced cable can turn the entire signal unbalanced.

Balanced use with XLR connectors

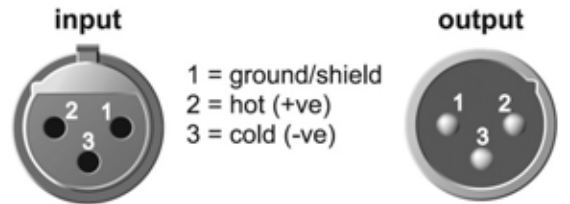

Fig .4.3 : XLR connections

Unbalanced 1/4" TS connector

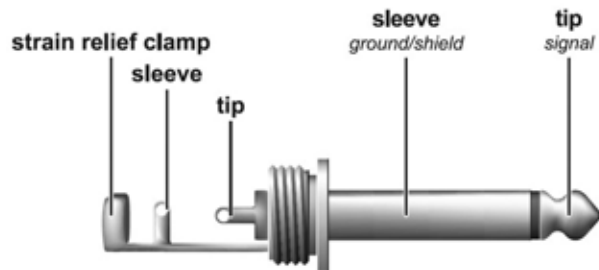
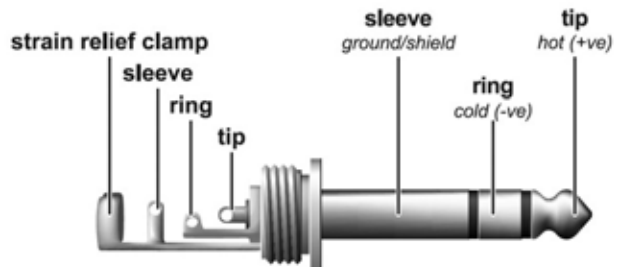

Fig .4.4: 1/4" TS connector

Balanced 1/4" TRS connector



For connection of balanced and unbalanced plugs, ring and sleeve have to be bridged at the stereo plug.

Fig .4.5: 1/4" TRS connector

PYLE PRO PEA4000/PEA6000

	PEA4000	PEA6000
Output Power		
20 Hz - 20 kHz@0.1%THD,both channels driven		
8 Ω per channel	260W	450W
4 Ω per channel	400W	650W
1 kHz@0.1%THD,both channels driven		
8 Ω per channel	280W	500W
4 Ω per channel	450W	750W
2 Ω per channel	700W	1200W
Bridged Mono		
8 Ω ,20Hz - 20kHz,0.1%THD	800W	1300W
8 Ω ,1kHz,0.1%THD	900W	1500W
4 Ω ,1kHz,1%THD	1400W	2400W
Distortion		
	< 0.01%	< 0.02%
Frequency Response		
at 10 dB below rated output power	20Hz - 20kHz, +0/-1 dB	
at -3 dB points	5Hz - 50kHz	
Damping Factor		
	> 300 @ 8 Ω	
Noise		
Unweighted, 20 Hz to 20 kHz	- 100 dB	
Voltage gain		
	40 \times (32 dB)	50 \times (34dB)
Input sensitivity		
V RMS(@8 Ω)	1.15V(+3.4 dBu)	1.23V(+4.0 dBu)
Input impedance		
	10k Ω unbalanced,20k Ω balanced	
Controls		
Front	Power switch,gain control(channels 1 and 2)	
Rear	DIP switches(10x)	
Indicators		
POWER	green LED	
CLIP	red LED,1 per channel	
SIGNAL	yellow LED,1 per channel	
Connectors		
Inputs	Balanced XLR and 1/4" TRS connectors	
Output	Touch-Proof binding posts and NEUTRIK SPEAKON	
Cooling		
	Continuously variable speed fan,back-to-front air flow	
Amplifier protection		
	Full short circuit,open circuit,thermal and HF protection Stable into reactive or mismatched loads	
Load protection		
	Turn-on/off muting,AC coupling	
Output circuit type		
	Class AB complementary linear output	Class H complementary linear output
Power supply		
Mains voltage/Breaker		
100-120V~, 50/60 Hz	15A	
220-230V~, 50/60 Hz	8A	
Power consumption	1600W	2600W
Mains connector	Standard IEC receptacle	
Dimensions/weight		
Dimensions(H x W x D)	approx.88 \times 482.6 \times 402 mm approx.3 1/2" \times 19" \times 15 4/5"	
Weight	approx. 15.7kg approx. 34.6lbs	approx. 16.6kg approx. 36.6lbs

6. Warranty

§ 1 Other warranty rights and national law

- 1.This warranty does not exclude or limit the buyer's statutory rights provided by national law,in particular,any such rights against the seller that arise from a legally effective purchase contract.
- 2.The warranty regulations mentioned herein are applicable unless they constitute an infringement of national warranty law.

§ 2 Online registration

Please do remember to register your new PYLE PRO equipment right after your purchase by visiting <http://www.pyleaudio.com> and kindly read the terms and conditions of our warranty carefully.

Registering your purchase and equipment with us process your repair claims quicker and more efficiently.

Thank you for your cooperation!

§ 3 Warranty

1. PYLE PRO warrants the mechanical and workmanship for a period of one (1) year * from the original date of purchase, in accordance with the warranty regulations described below. If the product shows any defects within the specified warranty period that are not excluded from this warranty as described under § 5, PYLE PRO shall, at its discretion, either replace the product by providing a new or reconditioned product or repair the product using suitable new or reconditioned parts. In the case that other parts are used which constitute an improvement, PYLE PRO may, at its discretion, charge the customer for the additional cost of these parts. In case PYLE PRO decides to replace the product, this warranty shall apply to the replacement product for the remaining initial warranty period, i.e one year * from the date of purchase of the initial product.
- 2.If the warranty claim proves to be justified, the product will be returned to the user freight prepaid.
- 3.Warranty claims other than those indicated above are expressly excluded.

§ 4 Return authorization number

- 1.To obtain warranty service,the buyer(or his authorized dealer)must call PYLE PRO during normal business hours BEFORE returning the product.All inquiries must be accompanied by a description of the problem. The buyer or his authorized dealer will receive a return authorization number.
- 2.Subsequently, the product must be returned in its original shipping carton, together with the return authorization number. The return shipment address will be indicated by PYLE PRO.
- 3.Shipments without freight prepaid will not be accepted.

§ 5 Warranty regulations

- 1.Warranty services will be furnished only if the product is accompanied by a copy of the original retail dealer's invoice. Any product deemed eligible for repair or replacement under the terms of this warranty will be repaired or replaced.
- 2.If the product needs to be modified or adapted in order in order to comply with applicable technical or safety standards on a national or local level, in any country which is not the country for which the product was originally developed and manufactured, this modification/adaptation shall not be considered a defect in materials or workmanship. The warranty does not cover any such modification/adaptation, irrespective of whether it was carried out properly or not. Under the terms of this warranty, PYLE PRO shall not be held responsible for any cost resulting from such a modification, adaptation.
- 3.Free inspections and maintenance/repair work are expressly excluded from this warranty. In particular, if caused by importer handing of the products by the user. This also applies to defects caused by normal wear and tear, in particular, of faders, crossfaders, potentiometers, keys/ buttons, tubes, guitar strings, illuminants and similar parts.
- 4.Damage/defects caused by the following conditions are not covered by this warranty:
 - ▲ improper handling, neglect or failure to operate the unit in compliance with the instructions given in PYLE PRO user or service manuals.
 - ▲ connection or operation of the unit in any way that does not comply with the technical or safety regulations applicable in the country where the product is used.
 - ▲ Damage/defects caused by force majeure or any other condition that is beyond the control of PYLE PRO.
- 5.Any repair or opening of the unit carried out by unauthorized personnel (user included) will void the warranty.
- 6.If an inspection of the product by PYLE PRO shows that the defect in question is not covered by the warranty, the inspection costs are payable by the customer.
- 7.Products which do not meet the terms of this warranty will be repaired exclusively at the buyer's expense. PYLE PRO will inform the buyer of any such circumstance. If the buyer fails to submit a written repair order such costs will also be invoiced separately.

§ 6 Warranty transferability

This warranty is extended exclusively to the original buyer (customer of retail dealer) and is not transferable to anyone who may subsequently purchase this product. No other person (retail dealer, etc.) shall be entitled to give any warranty promise on behalf of PYLE PRO .

§ 7 Claim for damages

Failure of PYLE PRO to provide proper warranty service shall not entitle the buyer to claim (consequential) damages. In no event shall the liability of PYLE PRO exceed the invoiced value of the product.



WWW.PYLEAUDIO.COM

IMPORTANT: PACK CAREFULLY IN ORIGINAL CARTON IF POSSIBLE. WE ARE NOT RESPONSIBLE FOR DAMAGE INCURRED IN RETURNING ITEMS FOR REPAIR. A LETTER STATING YOUR EXACT STREET ADDRESS, DAYTIME PHONE NUMBER, AND THE PROBLEM YOU ARE EXPERIENCING SHOULD BE INCLUDED. YOU MUST ALSO ENCLOSE A COPY OF THE ORIGINAL RECEIPT A SPROOF OF DATE OF PURCHASE

**PYLE SERVICE CENTER
1600 63RD STREET
BROOKLYN, NY 11204
1-800-444-5671**